

Varenummer: 0125057
 Beskrivelse: Seeger låsering SP40
 Fjederstål

Mål

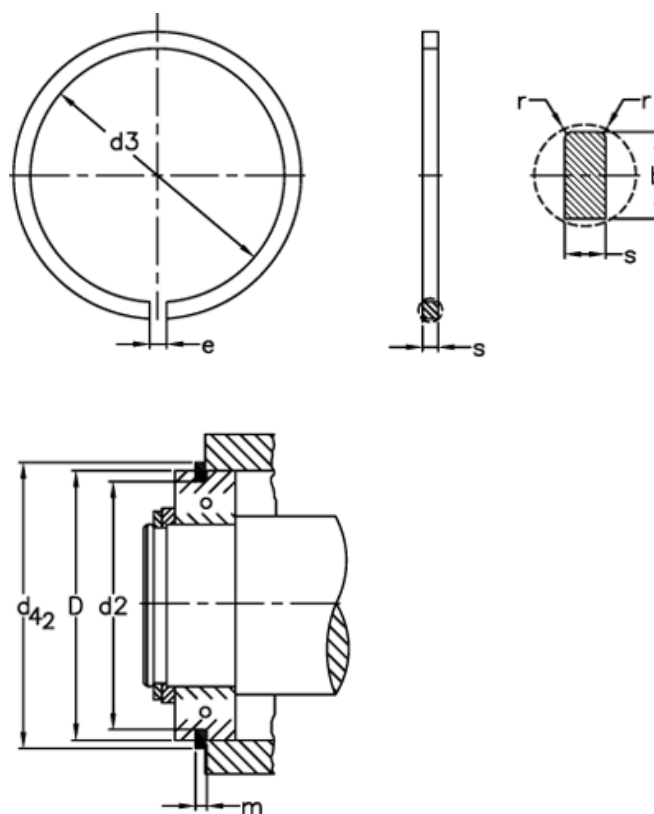

b	= 3.25	FRg kN	= 2.50	tol	= -0.15
Betegnelse	= SP 40	FR kN	= 13.5	tol	= -0.1
D	= 40	g	= 2.0	tol	= -0.25
d2	= 38.10	K kN-mm	= 24.2	tol	= 0.3
d3	= 37.3	m	= 1.35	tol	= 0.4
d42	= 44.6	n abl x 1000	= 8.0	vægt kg/1000	= 3.6
e	= 3	r min	= 0.4		
FN kN	= 19.3	s	= 1.12		